



**Pipe &  
Industrial  
Tools™**

## PIPE JACKS AND STANDS



# FIXED AND FOLDING PIPE JACKS (TRI PIPE STAND)



FIXED



FOLDING

**B&B Pipe & Industrial Tools** - The pipe jacks and pipe stands are backed with over 25 years of manufacturing experience. All pipe jacks and pipe stands are rated with at least a 2:1 safety ratio that is 3rd party tested. We have made B&B pipe jacks the strongest, most durable products on the market. B&B also offers an extensive range of head options for any pipe fabrication application.

### Specifications

- 2,500lbs / 1,135 kg load capacity
- Third party tested with at least a 2:1 safety ratio.
- Oversized 10" V-head for increased safety.
- Oversized square tube legs and braces for increased durability.
- 1½" ACME rod is largest in the industry.
- Quick lock washer height adjustment for easy use.
- More head options than any other manufacturer.
- Increased width stance for better stability.
- Square tube bracing offers additional strength and rigidity.
- Safety washer can be locked on to base for increased operator safety.



4100 - Fixed leg pipe jack (tri pipe stand) (includes V-head)

4100 - Fixed leg pipe jack (tri pipe stand) with 90029 large V-head



3900 - Folding leg pipe jack (tri pipe stand) (includes V-head)



**DESCRIPTION:** Fixed leg pipe jack (tri pipe stand) (includes V-head)

OLD PART NO		NEW PART NO		
TPS300 + TVH300		4100		
LOAD CAPACITY		WEIGHT		PIPE SIZE
2,500 lbs.	1,135 kg	19.85 lbs.	9.00 kg	Up to 24"

**DESCRIPTION:** Folding leg pipe jack (tri pipe stand) (includes V-head)

OLD PART NO		NEW PART NO		
TFS301 + TVH300		3900		
LOAD CAPACITY		WEIGHT		PIPE SIZE
2,500 lbs.	1,135 kg	22.30 lbs.	10.10 kg	Up to 24"

**DESCRIPTION:** V-head

OLD PART NO		NEW PART NO		
TVH300		90001		
LOAD CAPACITY		WEIGHT		PIPE SIZE
2,500 lbs.	1,135 kg	7.50 lbs.	3.40 kg	Up to 12"

**DESCRIPTION:** Large V-head (see 5 leg giant jack for accessories)

OLD PART NO		NEW PART NO		
TVH300L		90029		
LOAD CAPACITY		WEIGHT		PIPE SIZE
2,500 lbs.	1,135 kg	16.80 lbs.	7.60 kg	Up to 24"

**DESCRIPTION:** Steel wheel heads (slip on style) (pair)  
Stainless steel wheel heads (slip on style) (pair)

OLD PART NO		NEW PART NO		
SWH300		90060		
OLD PART NO		NEW PART NO		
* SWH300SS	* 90061			
LOAD CAPACITY		WEIGHT		PIPE SIZE
1,000 lbs.	450 kg	7.50 lbs.	3.40 kg	1" to 12"

**DESCRIPTION:** Steel wheel roller head  
Stainless steel wheel roller head

OLD PART NO		NEW PART NO		
SWH350		90002		
OLD PART NO		NEW PART NO		
* SWH350SS	* 90005			
LOAD CAPACITY		WEIGHT		PIPE SIZE
2,000 lbs.	910 kg	10.80 lbs.	4.90 kg	1" to 24"

**DESCRIPTION:** Phenolic wheel roller head

OLD PART NO		NEW PART NO		
* NWH350		* 90003		
LOAD CAPACITY		WEIGHT		PIPE SIZE
1,000 lbs.	450 kg	7.30 lbs.	3.30 kg	1" to 24"

**DESCRIPTION:** Phenolic wheel heads (slip on style) (pair)

OLD PART NO		NEW PART NO		
* NWH300		* 90032		
LOAD CAPACITY		WEIGHT		PIPE SIZE
1,000 lbs.	450 kg	4.40 lbs.	2.00 kg	1" to 12"

**DESCRIPTION:** Stainless steel head (slip on style) (pair)

OLD PART NO		NEW PART NO		
* SSH300		* 90004		
LOAD CAPACITY		WEIGHT		PIPE SIZE
3,500 lbs.	1,585 kg	2.20 lbs.	1.00 kg	1" to 12"



**DESCRIPTION:** Stainless steel ball transfer heads (slip on style) (pair)

OLD PART NO		NEW PART NO		
* BTH300SS		* 90000		
LOAD CAPACITY		WEIGHT		PIPE SIZE
1,000 lbs.	450 kg	5.50 lbs.	2.50 kg	1" to 12"

**DESCRIPTION:** Pipe chain vice head

OLD PART NO		NEW PART NO		
PCV300		90033		
LOAD CAPACITY		WEIGHT		PIPE SIZE
550 lbs.	250 kg	14.30 lbs.	6.50 kg	0.5" to 6"

**DESCRIPTION:** Conveyor roller head

OLD PART NO		NEW PART NO			
RBH300		90019			
LOAD CAPACITY		WEIGHT		PIPE SIZE	
500 lbs.	250 kg	9.40 lbs.	4.25 kg	Up to 12"	

**DESCRIPTION:** Conveyor V-head

OLD PART NO		NEW PART NO	
PBH300		90021	
90019	90021		





The B&B Duo pipe stand accommodates pipes up to 48", is height adjustable and equipped with quick change style heads.

The Duo pipe stand has locking brakes on the wheels to secure the load for marking, layout or fit-up and is now supplied with folding legs as standard for ease of use and transport and has an ultra safe pin locking design.



### Features and Advantages

- Load capacity 5,290 lbs. / 2,400 kg
- Folding legs for ease of transport and storage
- Self-centering head adjustment from either side
- Height adjustable 29 - 42.5" / 74.5 - 108 cm
- 2 - 48" / 51 - 1,219 mm pipe diameter capacity
- Quick height adjustment with additional fine thread for workpiece levelling
- 'Trued' wheels eliminate 'corkscrewing' of pipe during rotation
- Lockable wheels to hold pipe in position
- Safety pins to lock stand at working height
- CE conformity certified with CE mark

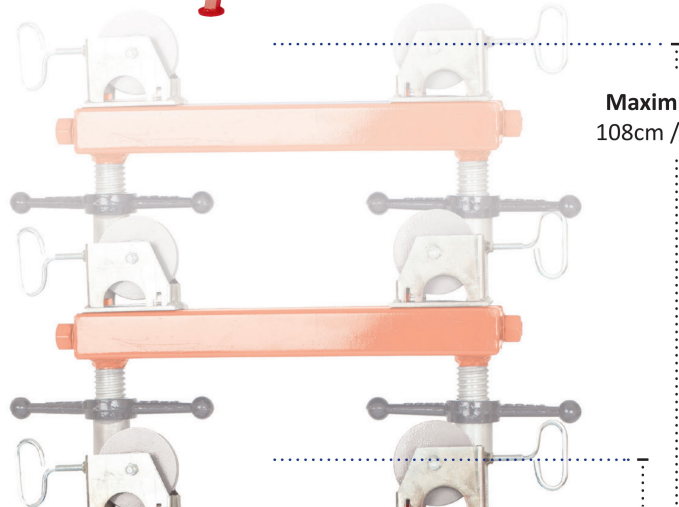

**Maximum:**  
108cm / 42.5"

**Minimum:**  
74.5cm / 29"

The Duo pipe stand utilises a fine adjustment thread. This allows precise adjustment of the working height and can compensate for uneven surfaces to ensure the pipe is level at all times.



The unique safety locking pins allow the Duo pipe stand to be fixed at various working heights.

Final adjustment and levelling can then be made with the fine adjustment handle.





# DUO PIPE STAND OPTIONS

The quick change style heads increase the versatility of the Duo pipe stand. The heads can be changed without tools in a matter of seconds to adapt to almost all applications. Roller wheels are available in steel, stainless steel or phenolic version. Ball transfer heads are available in steel or stainless steel.

## Simple head changeover



Various height holes enable the operator to fix the stand at the required working height using the safety locking pins

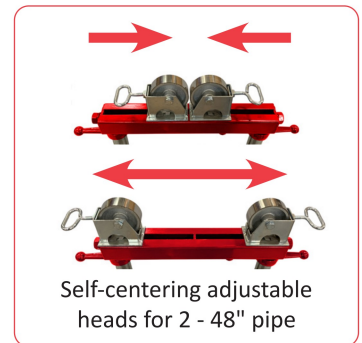

**DESCRIPTION:** Duo pipe stand (base unit only)

OLD PART NO	NEW PART NO	LOAD CAPACITY	WEIGHT
DPS200	90039	5,290 lbs. 2,400 kg	46.30 lbs. 21.00 kg

**DESCRIPTION:** Quick change steel/stainless steel wheel heads (pair)

OLD PART NO	NEW PART NO	LOAD CAPACITY	WEIGHT
SWH200	90065	5,290 lbs. 2,400 kg	6.60 lbs. 3.00 kg
* SWH200SS	* 90066	5,290 lbs. 2,400 kg	6.60 lbs. 3.00 kg

**DESCRIPTION:** Quick change phenolic wheel heads (pair)

OLD PART NO	NEW PART NO	LOAD CAPACITY	WEIGHT
* NWH200	* 90067	1,000 lbs. 450 kg	4.90 lbs. 2.20 kg

**DESCRIPTION:** Quick change stainless steel ball transfer heads (pair)

OLD PART NO	NEW PART NO	LOAD CAPACITY	WEIGHT
* BTH200SS	* 90068	3,197 lbs. 1,450 kg	6.60 lbs. 3.00 kg

\* Suitable for stainless steel



The B&B 5 leg giant jack is ideal for large diameter pipes (up to 36" / 920 mm) and its V-head can be equipped with multiple options.

The 5 leg giant jack can be fitted with caster wheels, allowing pipe movement.

The 5 leg giant jack is characterised by its increased steel dimensions throughout, including 1 3/4" solid ACME rod, making it the toughest on the market.

### Specifications

- Urethane over steel casters with solid hub increase safety and durability.
- 5,000 lbs. capacity without wheels and casters.
- 2,500 lbs. capacity with steel wheels and urethane casters.
- Operating height with swivel casters: 32" - 44" / 82 - 112 cm
- Operating height with jack only: 24" - 36" / 61 - 92 cm
- Minimum - maximum pipe diameter 1" - 36"
- Solid 1 3/4" ACME-thread adjustment.
- 1 1/2" wide steel / phenolic wheels to reduce instances of "pipe travel".
- Can be purchased as a complete kit as shown: jack, casters, and wheels.
- Turning wheels available in steel, stainless steel, and phenolic.
- Multiple add-ons available, including stainless steel sleeves for contamination free fit-up, recommended hold down chain device for transport, ball transfer attachments for variation of pipe movement and more.

**Maximum:**  
44" / 112cm

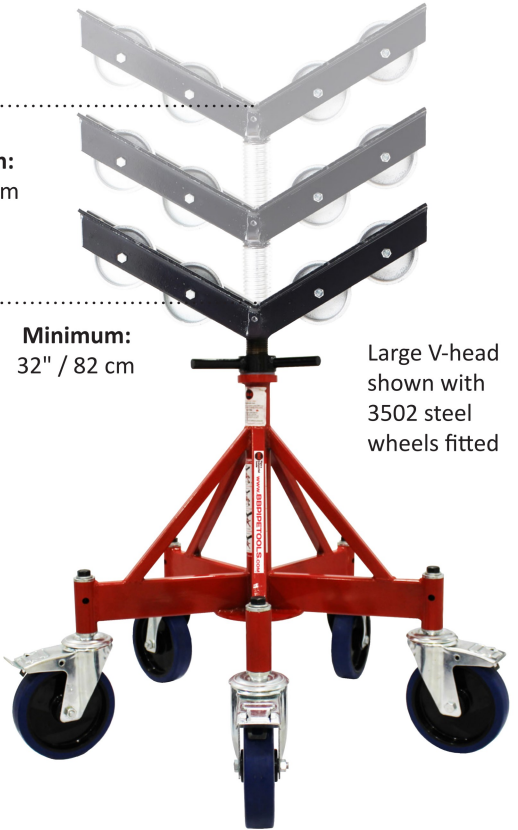

**Minimum:**  
32" / 82 cm

Large V-head shown with 3502 steel wheels fitted

Transport pipes around the site or workshop with ease.



Shown with 3504 caster wheel kit fitted and 3506 hold down chain device



Levelling pads supplied as standard



Hold down chain device 3506 locks pipe to jack



**Maximum:**  
36" / 92 cm

**Minimum:**  
24" / 61 cm

# 5 LEG GIANT JACK HEAD OPTIONS

*\* Suitable for stainless steel*

**DESCRIPTION:** 5 leg giant jack (base and V-head)

OLD PART NO	NEW PART NO			
QPS400 + QVH400	3500			
LOAD CAPACITY		WEIGHT		PIPE SIZE
5,000 lbs.	2,265 kg	64.00 lbs.	29.00 kg	n/a

**DESCRIPTION:** Steel wheel kit (4 wheels) - 1½" wide wheels

OLD PART NO	NEW PART NO	 V-head not included		
SWH400	3502			
LOAD CAPACITY		WEIGHT		PIPE SIZE
2,500 lbs.	1,135 kg	12.30 lbs.	5.60 kg	1" to 36"

**DESCRIPTION:** Stainless steel wheel kit (4 wheels) - 1½" wide wheels

OLD PART NO	NEW PART NO	 V-head not included		
* SWH400SS	* 3508			
LOAD CAPACITY		WEIGHT		PIPE SIZE
2,500 lbs.	1,135 kg	12.30 lbs.	5.60 kg	1" to 36"

**DESCRIPTION:** Phenolic wheel kit (4 wheels) - 1½" wide wheels

OLD PART NO	NEW PART NO	 V-head not included		
* NWH400	* 3503			
LOAD CAPACITY		WEIGHT		PIPE SIZE
1,000 lbs.	450 kg	4.40 lbs.	2.00 kg	1" to 36"

**DESCRIPTION:** Ball transfer stainless steel (pair)

OLD PART NO	NEW PART NO	 V-head not included		
* BTH400/SS	* 3509			
LOAD CAPACITY		WEIGHT		PIPE SIZE
1,000 lbs.	450 kg	6.60 lbs.	3.00 kg	1" to 36"

**DESCRIPTION:** Stainless steel sleeves (pair)

OLD PART NO	NEW PART NO	 V-head not included		
* SSS400	* 3507			
LOAD CAPACITY		WEIGHT		PIPE SIZE
5,000 lbs.	2,265 kg	2.20 lbs.	1.00 kg	1" to 36"

**DESCRIPTION:** Hold down chain device

OLD PART NO	NEW PART NO			
HDD400	3506			
LOAD CAPACITY		WEIGHT		PIPE SIZE
n/a	n/a	15.40 lbs.	7.00 kg	1" to 36"

**DESCRIPTION:** Caster roller wheel kit for PN 3500 (5 casters)

OLD PART NO	NEW PART NO			
RWK400	3504			
LOAD CAPACITY		WEIGHT		PIPE SIZE
2,500 lbs.	1,135 kg	37.5 lbs.	17.00 kg	n/a





The B&B Six-foot folding pipe jack is ideal for pipe holding and leveling in high places. With a top height of 72" / 180 cm tall and a bottom adjustment of 39" / 99 cm, the Six-foot jack can be used for many applications.

The Six-foot jack is foldable and can be carried with ease, fitting into tight spaces when transporting. The height adjustment is performed with a locking tube and 1½" ACME adjustment.

### Specifications

- Height adjustment: 39" - 72" / 99 - 180 cm
- Weight capacity: 1,000 lbs. / 450 kg
- Extra wide 38" footprint increases stability.
- Lock washer can be fastened to base for safety.
- 1½" ACME-thread adjustment.
- Folding design allows easy access into tight work spaces.
- Bottom T-handle locks folding base into fixed position.
- Pipe diameter: 1" - 12"



90060 - Steel wheel head



90032 - Phenolic wheel head



90000 - Ball transfer head



OLD PART NO	NEW PART NO	DESCRIPTION	WEIGHT CAPACITY	WEIGHT	ADJUSTMENT HEIGHT	FOOTPRINT
HPS600	3610	Six foot folding pipe jack with V-head	1,000 lbs. / 450 kg	44.10 lbs. / 20.00 kg	39" - 72" / 99 - 182 cm	38" / 96.5 cm

# ROLLER STAND (HEAVY DUTY)

*Floor or bench mountable pipe trestles*



These heavy duty stands are designed to be either floor or bench mounted. Available with 4 adjustable head styles to suit pipes from 4 - 48" / 100 - 1,220 mm.

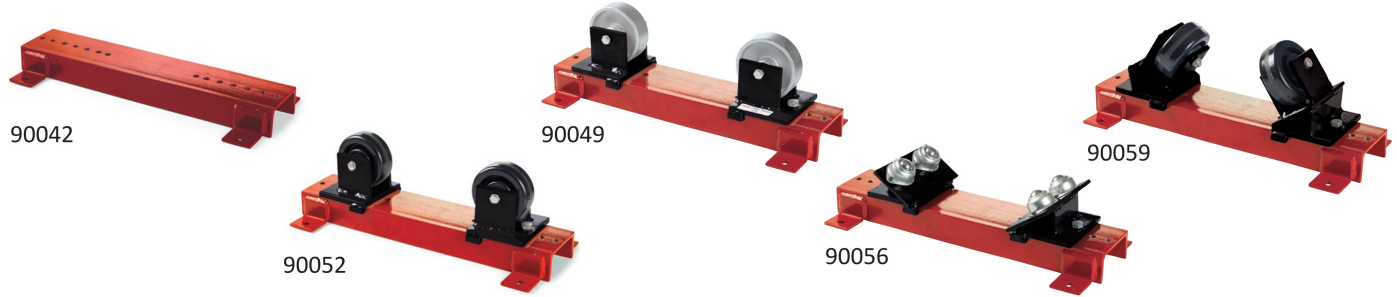

The above part numbers are for wheel heads only. Base (90042) not included.

OLD PART NO	NEW PART NO	DESCRIPTION	WEIGHT CAPACITY		PIPE DIAMETER CAPACITY		UNIT WEIGHT	
RPS500	90042	Base unit only	5,290 lbs.	2,400 kg	4" - 48"	100 - 1,220 mm	12.80 lbs.	5.80 kg
SWH500	90049	Steel wheel heads (pair)	5,290 lbs.	2,400 kg	4" - 48"	100 - 1,220 mm	7.70 lbs.	3.50 kg
* SWH500SS	* 90050	Stainless steel wheel heads (pair)	5,290 lbs.	2,400 kg	4" - 48"	100 - 1,220 mm	7.70 lbs.	3.50 kg
* NWH500	* 90052	Phenolic wheel heads (pair)	1,000 lbs.	450 kg	4" - 48"	100 - 1,220 mm	4.90 lbs.	2.20 kg
* BTH500SS	* 90056	Stainless steel ball transfer heads (pair)	1,000 lbs.	450 kg	4" - 48"	100 - 1,220 mm	7.70 lbs.	3.50 kg
S/FTR500	90057	Steel feed through roller (pair)	5,290 lbs.	2,400 kg	4" - 48"	100 - 1,220 mm	7.70 lbs.	3.50 kg
* SS/FTR500	* 90058	Stainless steel feed through roller (pair)	5,290 lbs.	2,400 kg	4" - 48"	100 - 1,220 mm	7.70 lbs.	3.50 kg
* N/FTR500	* 90059	Nylon feed through roller head (pair)	1,000 lbs.	450 kg	4" - 48"	100 - 1,220 mm	6.60 lbs.	3.00 kg

\* Suitable for stainless steel

# QUICK CHANGE ROLLERS

*Rapid, self centering pipe trestles*



This quick change roller stand is the top part of the popular duo pipe stand and is suitable to be floor or bench mounted. Available with 2 adjustable head styles to suit pipes from 2" - 48" / 50 - 1,220 mm.

**DESCRIPTION:** Quick change roller (base unit only)



OLD PART NO.	NEW PART NO	LOAD CAPACITY		WEIGHT	
QCR501	90063	5,290 lbs.	2,400 kg	13.00 lbs.	5.90 kg

**DESCRIPTION:** Quick change steel/stainless steel wheel heads (pair)

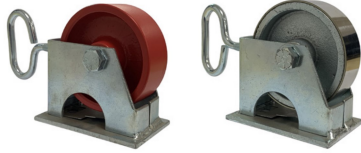

OLD PART NO.	NEW PART NO	LOAD CAPACITY		WEIGHT	
SWH200	90065	5,290 lbs.	2,400 kg	6.60 lbs.	3.00 kg
* SWH200SS	* 90066	5,290 lbs.	2,400 kg	6.60 lbs.	3.00 kg

**DESCRIPTION:** Quick change phenolic wheel heads (pair)



OLD PART NO.	NEW PART NO	LOAD CAPACITY		WEIGHT	
* NWH200	* 90067	1,000 lbs.	450 kg	4.90 lbs.	2.20 kg

**DESCRIPTION:** Quick change stainless steel ball transfer heads (pair)



OLD PART NO	NEW PART NO	LOAD CAPACITY		WEIGHT	
* BTH200SS	* 90068	3,197 lbs.	1,450 kg	6.60 lbs.	3.00 kg

\* Suitable for stainless steel

# UNO PIPE JACK STAND

*Specialist pipe stand for low level and tight access*



The UNO pipe jack stand is a basic single tubed pipe stand, simple to use and easy to set-up.

Popular for tight access jobs in power stations, submarines, refineries, etc.

A favourite for low level work in all fab shops.

Available in 4 standard heights.

Roller heads can also be fitted to the V-head of the UNO pipe jack stand to suit varying applications.



90060 - Steel wheel head



90032 - Phenolic wheel head



90000 - Ball transfer head

PART NO	DESCRIPTION	MIN/MAX HEIGHT		LOAD CAPACITY		PIPE SIZE
UPS01	Uno pipe jack stand - size 1 (base only)	7" - 10.6"	175 - 270 mm	1,000 lbs.	450 kg	up to 12"
UPS02	Uno pipe jack stand - size 2 (base only)	10.6" - 15.2"	270 - 385 mm	1,000 lbs.	450 kg	up to 12"
UPS03	Uno pipe jack stand - size 3 (base only)	15.2" - 20"	385 - 510 mm	1,000 lbs.	450 kg	up to 12"
UPS04	Uno pipe jack stand - size 4 (base only)	20" - 25"	510 - 635 mm	1,000 lbs.	450 kg	up to 12"
90001	V-head - 5" / 127 mm	-	-	2,500 lbs.	1,135 kg	up to 12"

**90001 V-head: Please refer to fixed and folding pipe jack head options for full technical specifications**

*We can manufacture to any height with 5" / 125mm range*

# TRI-STAND CHAIN VICE



The B&B Tri-stand chain vice is a proven design used on construction sites around the globe.

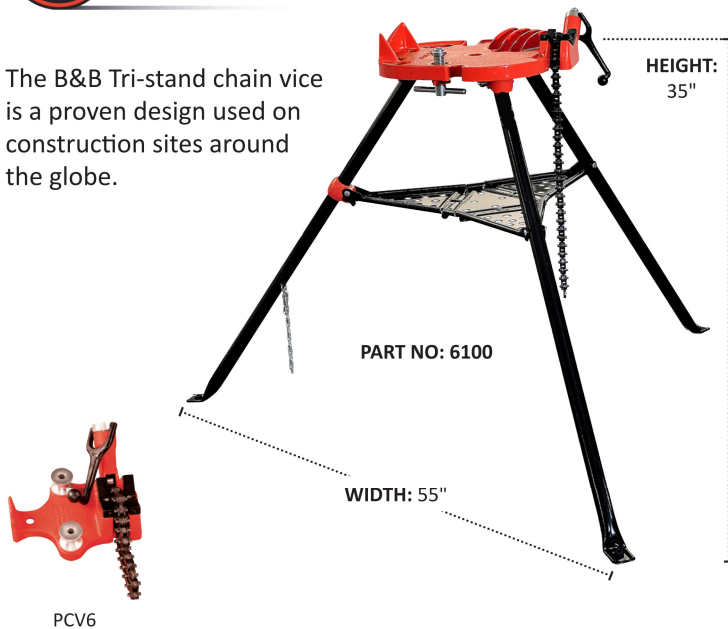

### Specifications

- Durable cast aluminium head balances lightweight and durability.
- Heavy duty hold down tightening device with replaceable jaw.
- Folding legs with chain lock.
- Leg bracing doubles as a lipped shelf for holding additional tooling and machines.
- Up to 6" pipe capacity
- Boxed and fully assembled, ready for immediate use (box dimensions: 46" x 18" x 16")
- Heavy duty jaws
- 55" width x 35" height (working dimensions)
- 1,000 lbs. / 450 kg capacity

OLD PART NO	NEW PART NO	DESCRIPTION	SHIPPING WEIGHT	
TCVS6	6100	Tri-stand chain vice - up to 6" pipe diameter capacity	41.90 lbs.	19.00 kg
PCV6	90041	Pipe chain vice clamp - up to 6" pipe diameter capacity	11.00 lbs.	5.00 kg